



Bullet Flood LED Light



Date: Location:

Product: Project:

Quantity: Catalog#

FEATURES

- Beautiful bullet flood landscape lighting
- Easy to install and operate with 30/40/50k tunable colors.
- Energy saving, long lifespan
- Light is soft and uniform, safe to eyes.
- Instant start, NO flickering, NO humming
- Green and eco-friendly without mercury

SUITABLE APPLICATIONS

- Outdoor basketball court, tennis court
- Badminton court, the football field
- The school playground, stadium
- Community leisure entertainment plaza
- Warehouse, factory and workshops
- Highway toll station
- Meeting room, exhibition hall
- Gymnasium and supermarkets, etc. plaza,

CONSTRUCTION:

Heavy die-cast aluminum alloy housing with bronze powder-coated finish.

ELECTRICAL:

Available as 120-277V input, 0-10V dimmable. -40°C to 45°C.

OPTICAL SYSTEM:

Lumileds 2835LED chips. High quality tempered PC lens optics. 38° beam angle.

INSTALLATION & MOUNTING:

Angle-adjustable Knuckle Bracket mount for pole mounting.

WARRANTY:

5-year limited warranty. Actual performance may differ as a result of end-user environment and application.

PERFORMANCE

| Model NO | Power Factor | Wattage | Voltage/Current Input | | Light Efficiency | Kelvin Options |
|--------------------|--------------|---------|-----------------------|-------|------------------|-------------------|
| | | | 120V | 277V | | |
| AST-FL17-25WBH5DA1 | 0.9 | 25W | 0.2A | 0.36A | 128LM/W | 3000K/4000K/5000K |

V4 Flood LED Luminaire

Electric Characteristic

| Specification/Model | AST-FL17-25WBH5DA1 | | |
|-------------------------|---------------------|----------------|----------------|
| LED Driver | UL listed BHE Brand | | |
| Input power | 25W | 25W | 25W |
| Lumens output | 3200LM | 3200LM | 3200LM |
| Efficiency | 128LM/W | 128LM/W | 128LM/W |
| CRI | >80 | >80 | >80 |
| Color Temperature | 3000K | 4000K | 5000K |
| Input voltage | 120-277V/AC | 120-277V/AC | 120-277V/AC |
| Light distribution type | 120D | 120D | 120D |
| Working temperature | -40+45°C | -40+45°C | -40+45°C |
| Junction temperature | <75°C | <75°C | <75°C |
| lamps efficiency | ≥90% | ≥90% | ≥90% |
| Certificate | UL CUL DLC | UL CUL DLC | UL CUL DLC |
| Equivalent | 50-100W MH/HPS | 50-100W MH/HPS | 50-100W MH/HPS |

DIMENSION

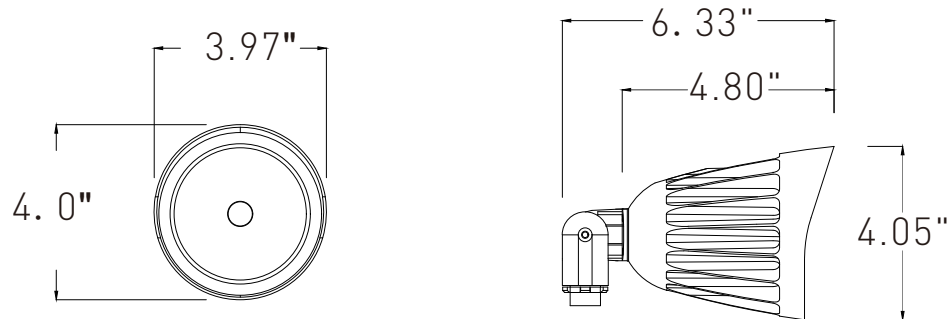

DISTRIBUTION DIAGRAM

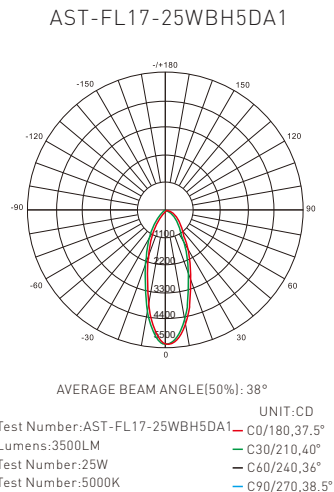

V4 Flood LED Luminaire

LED Flood Light Instruction

Cautions:

1. Can not use the electric generator to test the LED light.
2. Please abide by related country, regional and local law and regulations when install this fixture.
3. To avoid electrical shock and damage, please do not install the lights in raining days.
4. Please turn off the power before installation or maintenance. Proper grounding is required to ensure safety.

Notices:

1. To prevent from electric shock or fire risk, installation must be conducted by operator with professional electrical knowledge.
2. Please wear gloves to avoid injury before installing lights.
3. During or after installation, if there are situations such as smoke, fire in the wires or lights, please turn off the power immediately and notify relevant personnel for an overhaul.
4. This light can be used for outdoor installation.

Wiring Diagram:

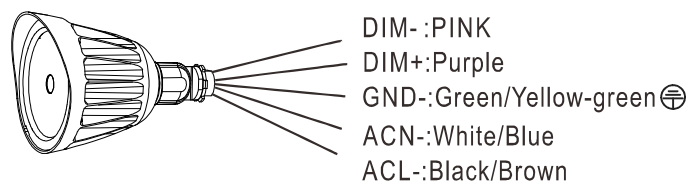

1/2 ADJUSTABLE FITTER MOUNTING (1/2AM)

Step 1: Take the light out of package(Figure1);

Step 2: Finish wire connection according to the right mode of connection [pay attention to positive wire, negative wire, and ground wire], and then put wire into light pole(Figure2);

Step 3: Loosen screws; adjust fixture angle as per actual demands and tighten screws later; Tips: Angle of the fixture is adjustable(Figure3); (pass the bracket through mounting surface, fix it with screws, then connect the wires as per proper wiring requirements.)(Figure4)

Step 4: when mounting on wall or ceiling with canopy, need to calk the all side to seal the mounting surface.(Figure.5)

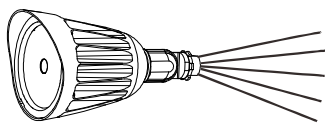

(Figure1)

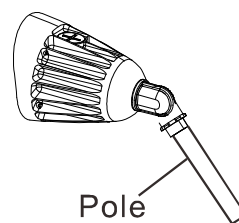

(Figure2)

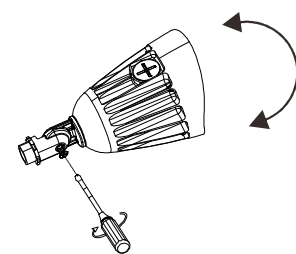

(Figure3)

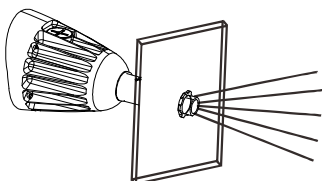

(Figure4)

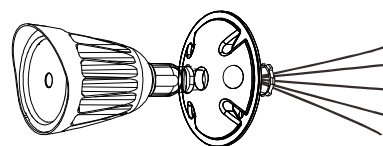

(Figure5)

V4 Flood LED Luminaire

1/2 ADJUSTABLE FITTER MOUNTING (1/2AM)

Step 1: Take the light out of package(Figure6);

Step 2: Finish wire connection according to the right mode of connection (pay attention to positive wire, negative wire, and ground wire), and then put wire into light pole(Figure7);

Step 3: Loosen screws; adjust fixture angle as per actual demands and tighten screws later; Tips: Angle of the fixture is adjustable(Figure8); (pass the bracket through mounting surface, fix it with screws, then connect the wires as per proper wiring requirements.)

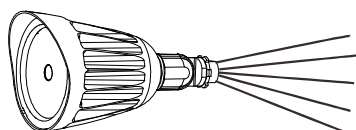

(Figure6)

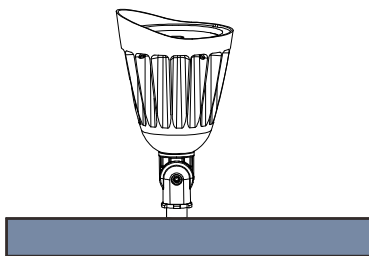

(Figure7)

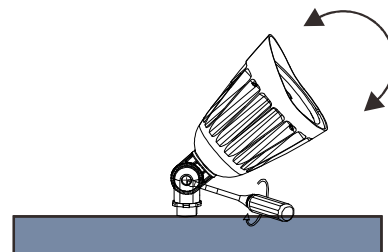

(Figure8)

Function adjustment

Step 1: Open the metal plug and with a screwdriver (figure9), Then slide the switch left and right to adjust the CCT controller, Adjust the color temperature as required (figure10).

Step 2: After adjusting the required control function, tighten the metal plug (figure11).

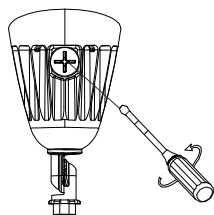

(Figure9)

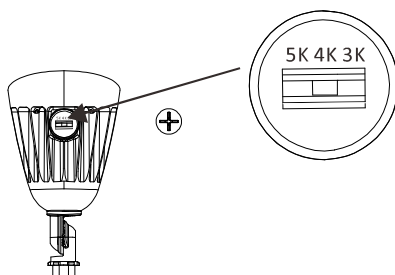

(Figure10)

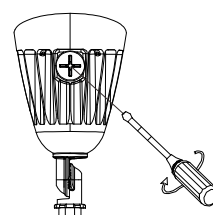

(Figure11)